

RobLight

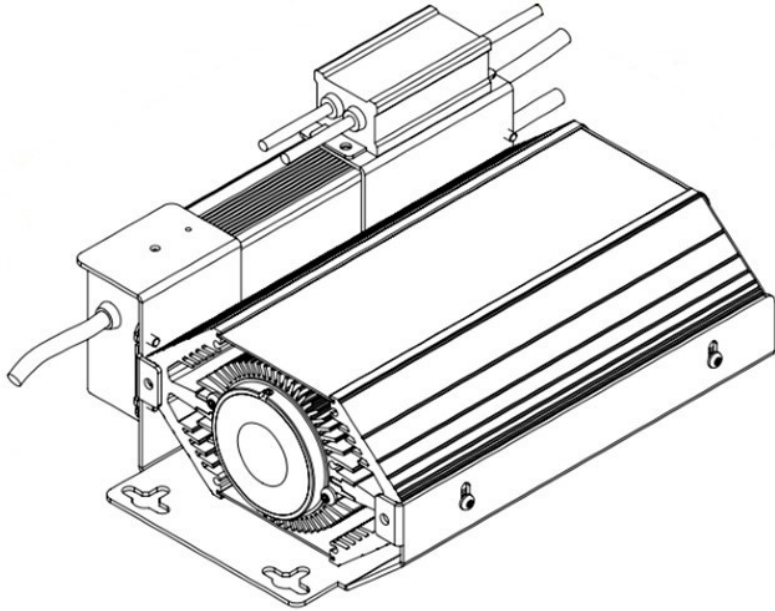

FL 1500 C DMX DIM

User manual

RobLight

Introduction

The RobLight FL 1500 C DMX DIM light generator is designed for indoor use in dry locations with glass and PMMA fibre harness Ø28 mm. It can be used in all installations set-ups, including closed compartments if limits for max ambient temperature are followed.

Product overview/unboxing

- 1 FL 1500 C DMX DIM
- 1 User manual
- 1 Allen key



Installation instructions

Follow the installation instructions to ensure

- Safe operation
- Full functionality
- Stated expected lifetime
- Uninterrupted illumination

RobLight

Warning

This device has a built in high power phosphor converted blue led. The light source is grouped in Risk Group 2.

Risk group 2



CAUTION.
Possibly hazardous optical radiation emitted from this product. Do not stare at operating lamp. May be harmful to the eye.

Do not look into the light port when lit.

Beware of placing highly light absorbing material directly in front (distance 0-1cm) of the port or a fibre. The extremely high intensity will increase the temperature in the material.

Using non RobLight harnesses in this light generator is at your own risk.

Ensure that the polyconnector is undamaged and clean before using the light generator in retrofit RobLight installations.

Beware that when the or a light generator is operated at max ambient temperature the surface temperature can exceed 75°C.

The light generator is only tested with RobLight standard polyconnector end.

Warranty label

The warranty label is not to be broken under ANY circumstances. If broken the warranty is terminated.

Technical data

General

Light port	Ø28 mm
Fibre type	PMMA or glass
Material	Aluminium, POM and other
Dimensions (L x H x W)	250 x 120 x 205 mm
Weight (total)	5500 g
Safety	CE, RoHS, WEEE

Environmental

Protection rating	IP 20
Thermal protection	Integrated auto
Cooling	Axial fan
Ambient temperature	-10° to 45° C

Driver/electrical

Driver	LED driver constant current
Supply voltage (mains)	100-240V 50/60Hz
Driver expected lifetime	100.000 hours (@TC = 65° C)
Total power consumption	115W
Dimmer systems applicable	DMX
Fan expected lifetime	40.000 hours
Fan sound level	30dB (A)

Light source

Applied LED	Nichia
LED expected lifetime	>35.000 hours @Ta = 45° C
Typical CCT	3000K or 4000K, 3SDMC
Typical Ra (CRI ₁₋₈)	92+ (min 90)

RobLight

Installation instructions

- a) Remove cap from the light port
- b) Check that the end face of the polyconnector is clean and undamaged
- c) Insert the polyconnector fully in the light port
- d) Tighten the screw onto the light port with an Allen key
- e) Ensure all installation and ventilation requirements are met
- f) Connect the supply cord to the mains



RobLight

Vertical mounting F models

This light generator should not be mounted with light port upwards. At high ambient temperature the operational lifetime of the internal components and harness will be reduced.

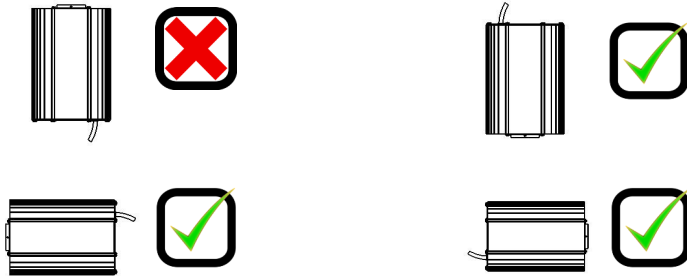

Mounting (Accessories)

Attach to surface using 4 screws in the baseplate holes. Be aware that the total weight of this system is more than 5,5 kg + the downforce from the fibre harness.

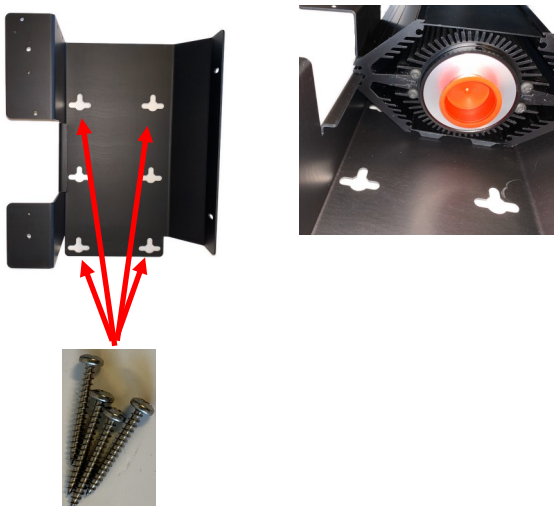

Closed compartments

MAX AMBIENT TEMPERATURE 45°C.

Recommendations: (should always be tested in a mock up)

Secure enough space to allow natural heat transmission through surfaces.

Surfaces should not be insulated.

Cooling air for the polyconnector can not be obstructed in any way, as it is essential to avoid damage to the harness.

General minimum distance from the light generator to any enclosing surface 10 cm (excluded mounting surface).

Air volume per light generator minimum 0.35 m³

(For insulated surfaces the volume has to be increased)

Airflow recommendation. Should be from obstacles inlet/outlet min 30 cm.

Beware of inlet and outlet ventilation holes opposite each other as shown on the drawing.

Keep free from dust and polluted air.

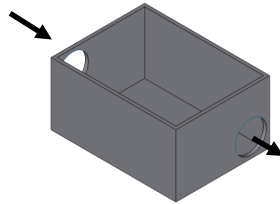

Installing adjacent light generators

Recommendation:

Minimum 30 cm distance between adjacent light generators to ensure enough free cooling air.

If multiple rows, use offset to avoid vertical rows. Minimal free distance between rows 40 cm.

Max temperature has to be observed for all light generators measured at air inlet for each light generator.

MAX AMBIENT TEMPERATURE 45°C.

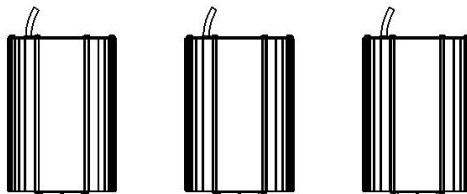

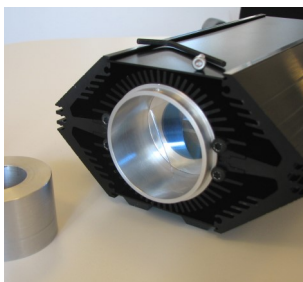
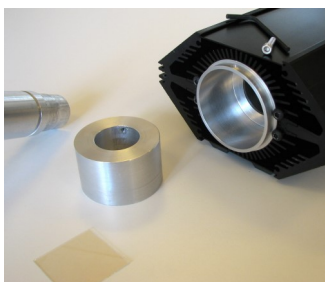
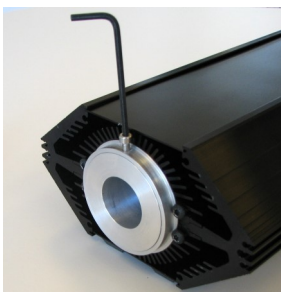
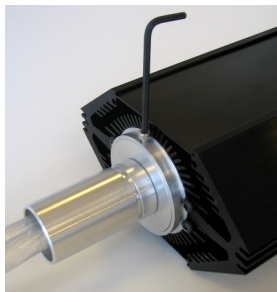

RobLight

Colour Filter



Accessories / Spare part

	Part name	Description	Item no.
	Adapter Ø28/Ø9	To change the light port from Ø28 to Ø9 mm	7800 0130
	Fan replacement kit	Repair kit with parts to install new fan	0130 8000

Maintenance, spare parts and repairs

The effectiveness of the active cooling device is greatly diminished if the cooling fins and the air intake is blocked or polluted with dust. This will reduce the expected lifetime of the product.

The dust must be removed on a regular basis. Interval depending on the environment.

A fine brush, vacuum cleaning or light compressed air can be used for the cleaning.

This light source is not supposed to be otherwise serviced, if used as recommended.

The fan can be replaced using standard tools. A replacement kit with guide is available.

If the product is not performing as specified, use the troubleshooting guide. If you need further assistance, please contact RobLight.

RobLight

Application notes

The light generator is an electronic device and must be handled accordingly. The different components will have different factors influencing the practical lifetime. The most important factor for this system is the condition of the surrounding air (temperature and cleanliness). The data we have stated about or and the expected lifetime of the key components, are at the temperatures that the suppliers have performed during their standardized tests in clean environments.

The light generator is designed to run at max ambient temperature, but the longest usable operation is achieved with lower temperatures.

Although there is thermal protection built into this device, it is only a safety device and should not be used as a measurement device to test if the light generator is running at a tolerable surrounding temperature.

The polyconnector is the most stressed part of this system. Care should be taken to ensure that the fibre ends are 100% clean and free from dust and grease (fingerprint will do damage). See www.rob-light.com for recommendations to clean fibre ends.

Running the light generator at too high temperatures will not only risk damage to the light source but also to the fibre harness.

KEEP COOL

CLEAN AIR

Troubleshooting

Problem	Trace the problem	Solution
No light	Check the power	Connect the power cord properly Turn on the device
	Check the temperature	Check if it is installed according to the instructions
	Check the dimming	Unplug the light generator. Unplug the dimmer system from the driver. Turn on the power
Light switches on and off	Check the operating conditions of the light generator	Check if it is installed according to the instructions
	Check the active cooling system	Remove dirt and dust from the light generator

If problems are not solved using this guide, please contact RobLight A/S.

RobLight

RobLight A/S, Gl. Skagensvej 105 H, DK-9900 Frederikshavn
T: +45 9244 4888, E: info@rob-light.com
www.rob-light.com